

| Rev | Datum | Door |
|-----|----------|------|
| - | 1-9-2020 | RBO |

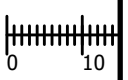

| | | | | |
|--|--|--|---|------------------------|
| | Falco BV Postbus 18 7670AA Vriezenveen | T +31 (0)546 55 44 44 F +31 (0)546 56 11 15 I www.falco.nl | Tuotenmero: 01.424.050 | Revisie: - |
| | Tekenaar: RBO | Maateenheid: mm | Tuotekuvaus: Yksipuoleinen Falco Koppla, 4 pp, k-k 50 cm, 90° | Formaati: A3 |
| | Getekend: 1-9-2020 | Schaal: 1 : 10 | | |
| | Documentnr.: E0067037.dwg - | Blad: 1 / 1 | | |

| Rev | Datum | Door |
|-----|----------|------|
| - | 1-9-2020 | RBO |

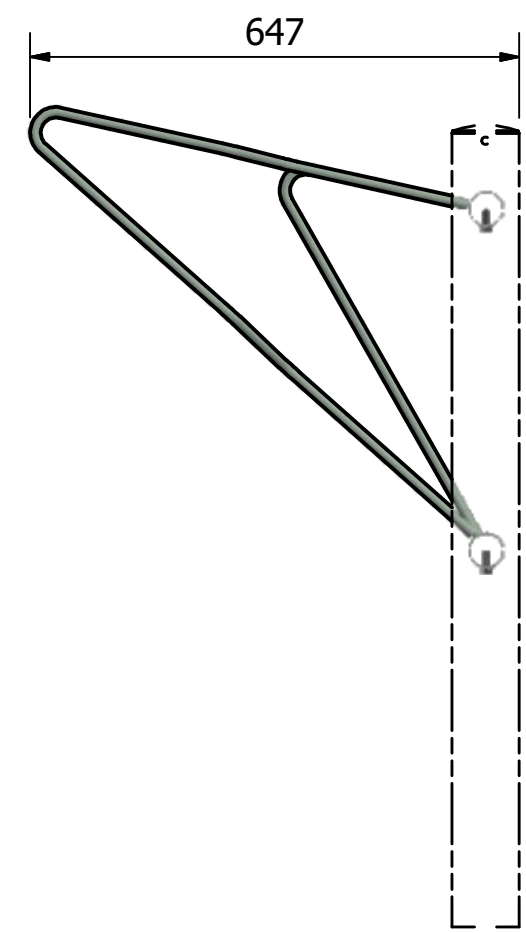
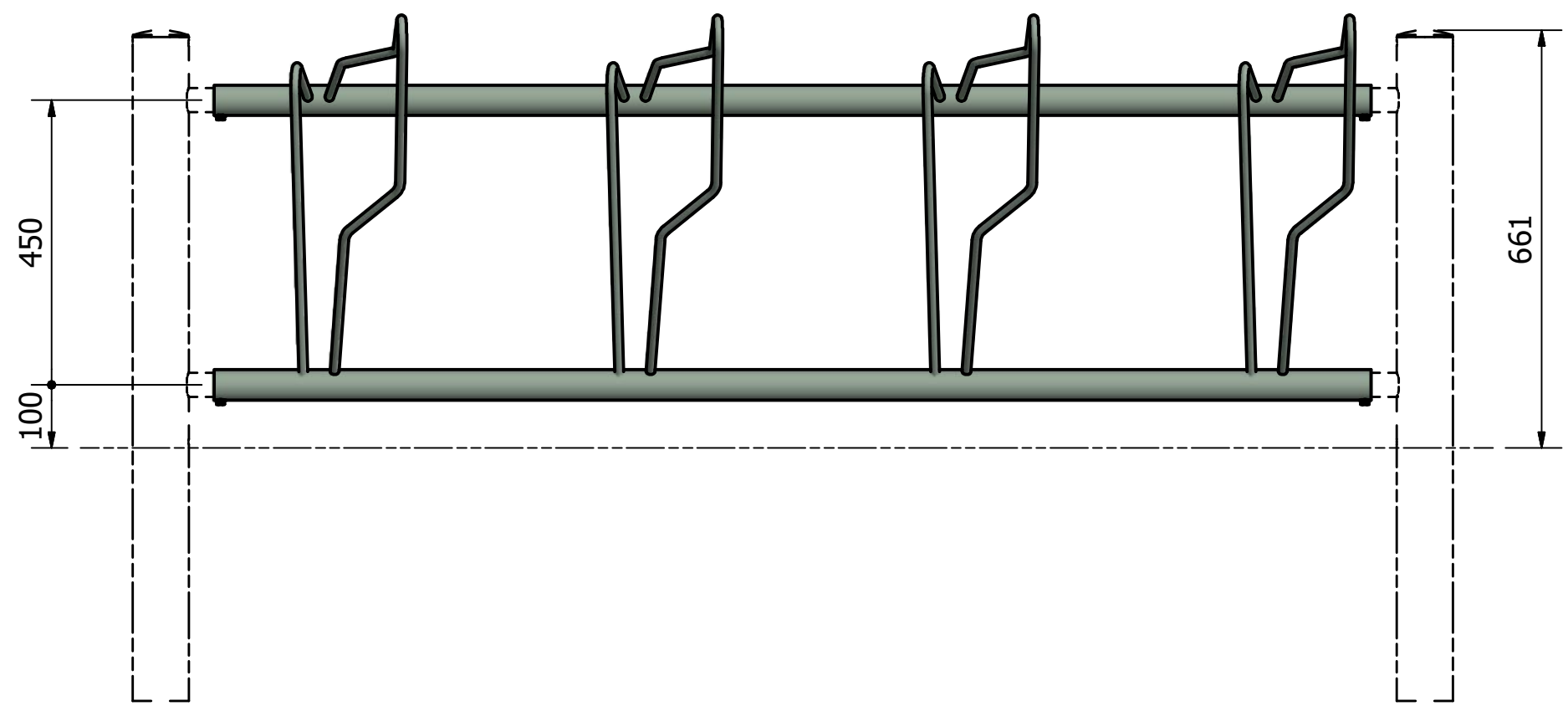
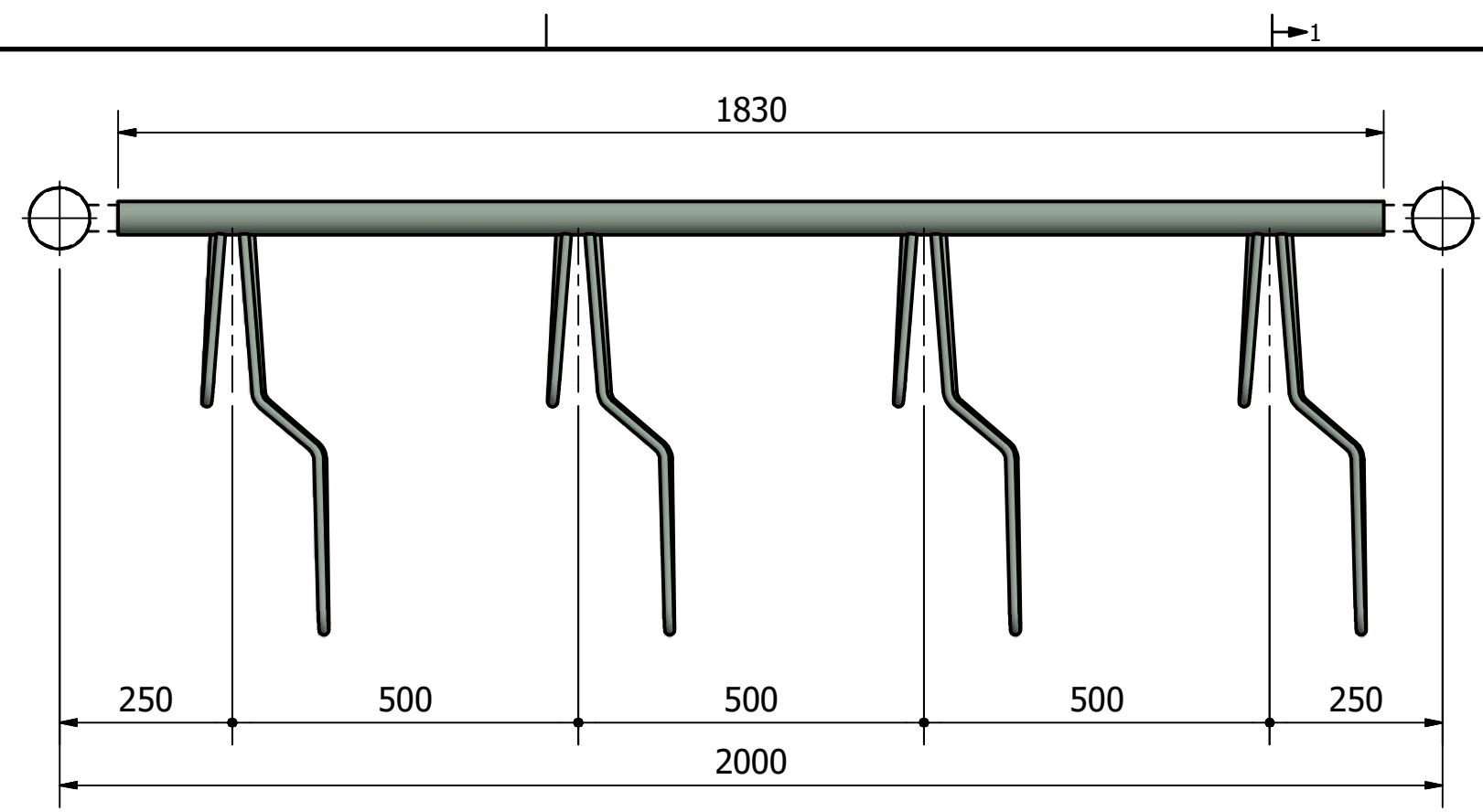
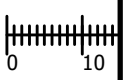
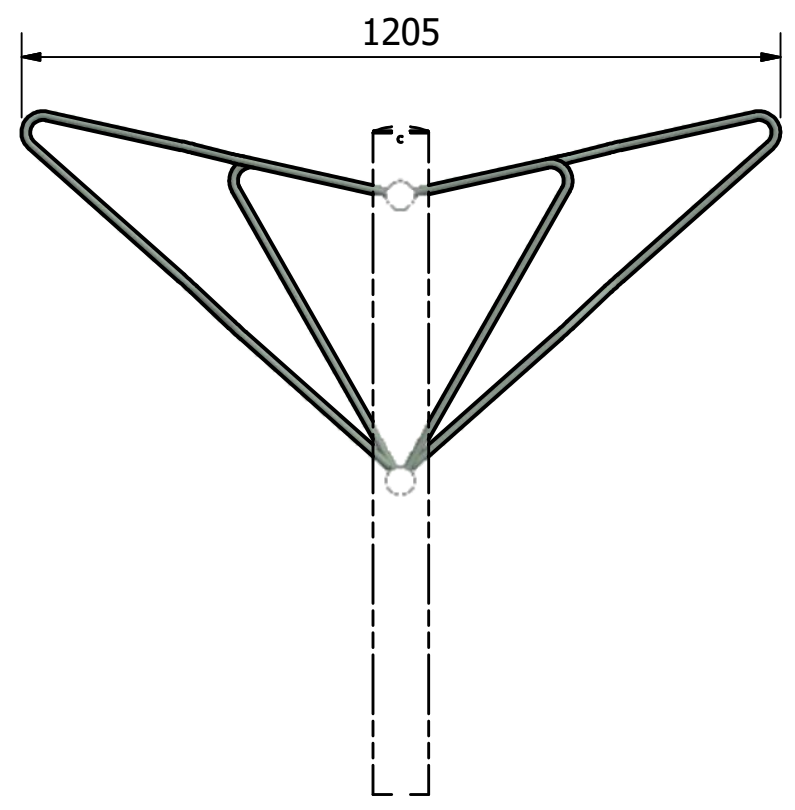
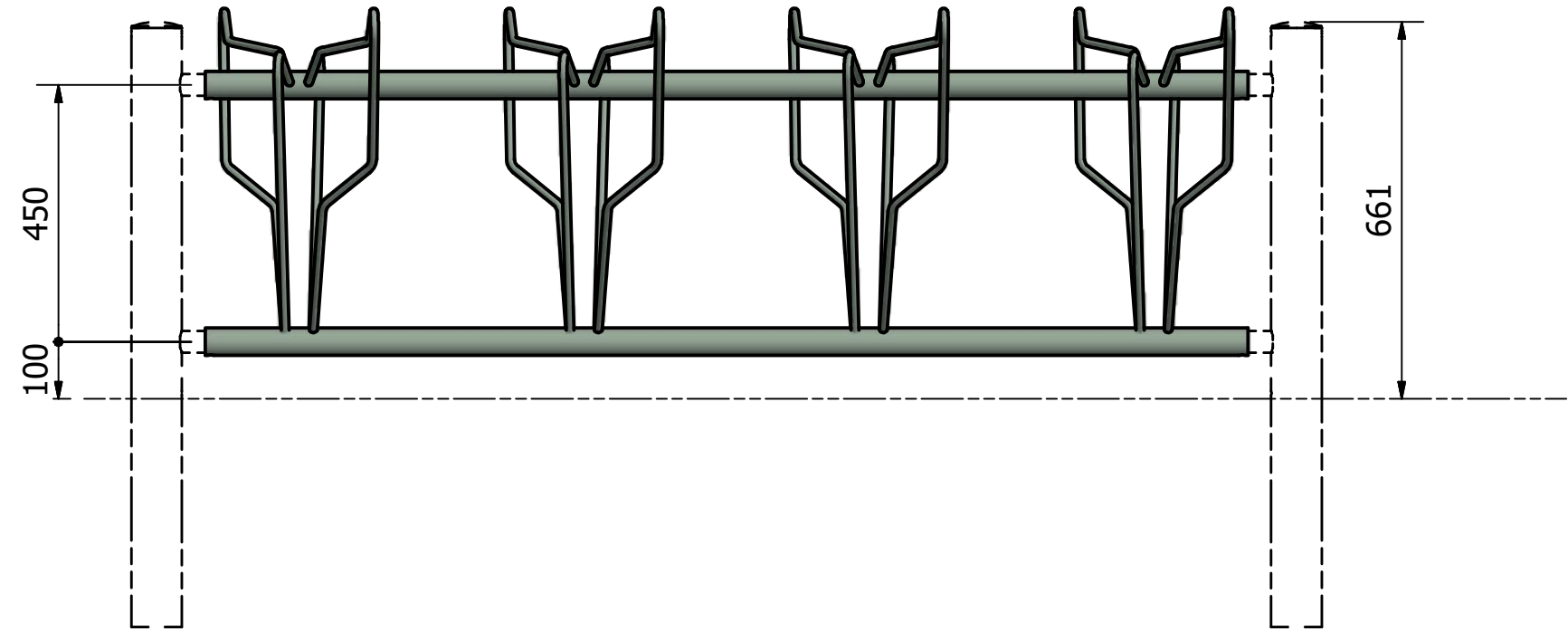
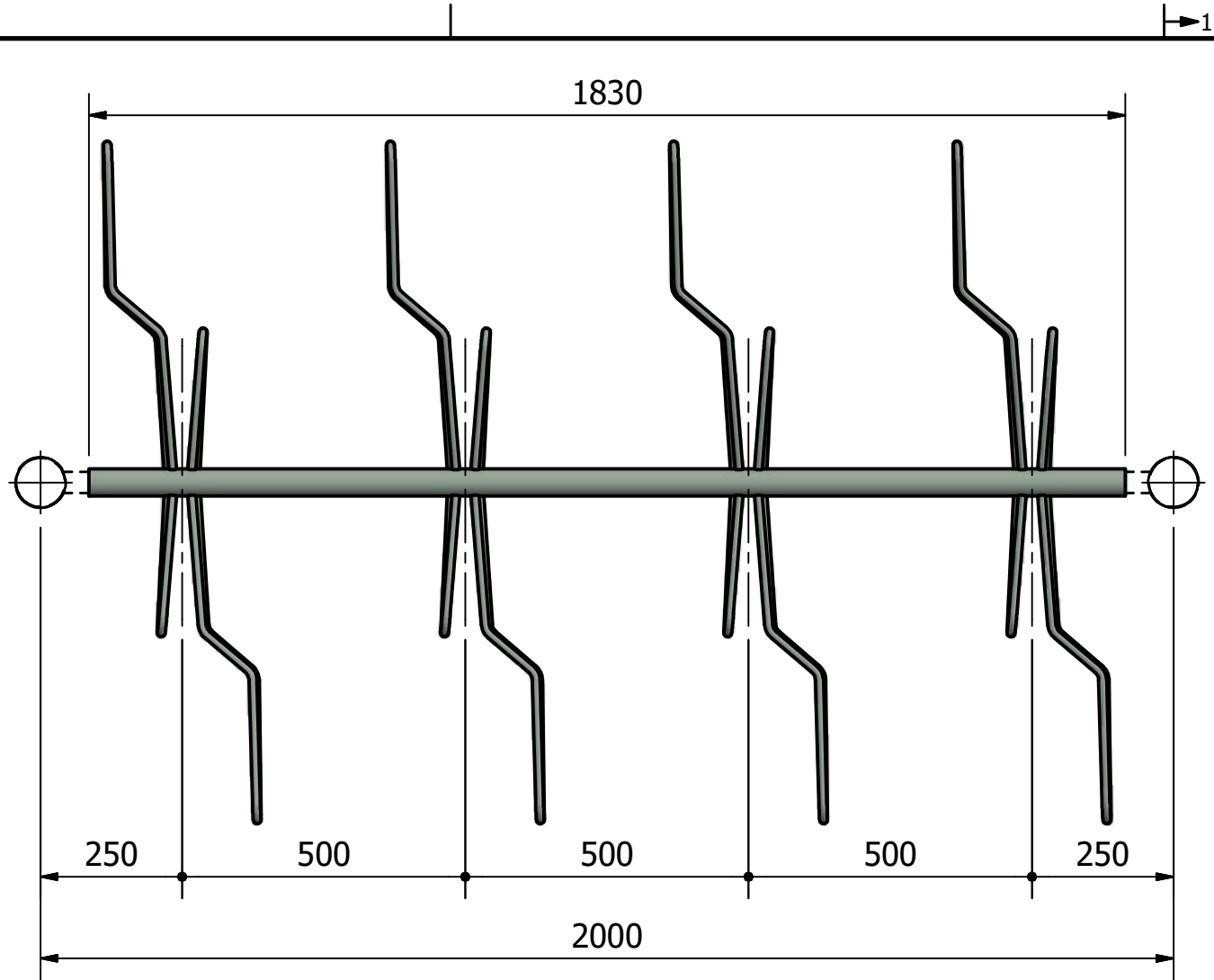

| | | | | |
|--------------------|--|--|--|------------------------|
| | Falco BV Postbus 18 7670AA Vriezenveen | T +31 (0)546 55 44 44 F +31 (0)546 56 11 15 I www.falco.nl | Tuotenumero: 01.438.050 | Revisie: - |
| | Tekenaar: RBO | Maateenheid: mm | Tuotekuvaus: Kaksipuoleinen Falco Koppla, 4+4 pp, k-k 50 cm, 90° | Formaati: A3 |
| Getekend: 1-9-2020 | Schaal: 1 : 12 | Documentnr.: E0067042.dwg - | Blad: 1 / 1 | |